



LINE HAUL & REGIONAL APPLICATIONS

# THE MICHELIN® X® MULTI Z - 315 TIRE

Designed with safety, grip and performance at the forefront for fleets operating in regional and line haul environments.

Line Haul	Regional	Urban	On/Off Road
Recommended	Acceptable		



(1)

SmartWay®  
Verified

(2)



(1) The wide arrow shows the recommended start-of-life mounting direction for optimal tread performance. The small arrow demonstrates the alternate rolling direction which may be used for the second half of tread life. Michelin recommends that all tires on the same axle have the arrows facing in the same direction.

(2) Based on internal tests against SmartWay® requirements. For more information on SmartWay® verified technologies, go to US: [www.epa.gov/smartway](http://www.epa.gov/smartway) or CA: [www.nrcan.gc.ca](http://www.nrcan.gc.ca).



# THE MICHELIN® X® MULTI Z - 315 TIRE

SmartWay®  
Verified

## EXCEPTIONAL HANDLING:

- **Infini-Coil® Technology** – provides a stable footprint and helps to protect the casing from road hazards due to a ¼ mile of steel cable wrapped circumferentially around the casing
- **Regenion Tread Sculpture** – helps to improve rubber footprint on the road while maintaining grip throughout the tread life
- **3PMSF** rated for steer and drive applications

## MILEAGE PERFORMANCE:

- **Designed to improve mileage** with an increased rubber contact patch and reduce irregular wear due to the stable footprint

## LONG LASTING GRIP:

- **Regenion Tread Sculpture** evolves, opening two additional circumferential grooves for water evacuation, to help provide wet grip when new or worn



100%

75%

50%

25%

- **Siping** provides an additional biting edge for traction

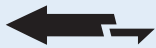
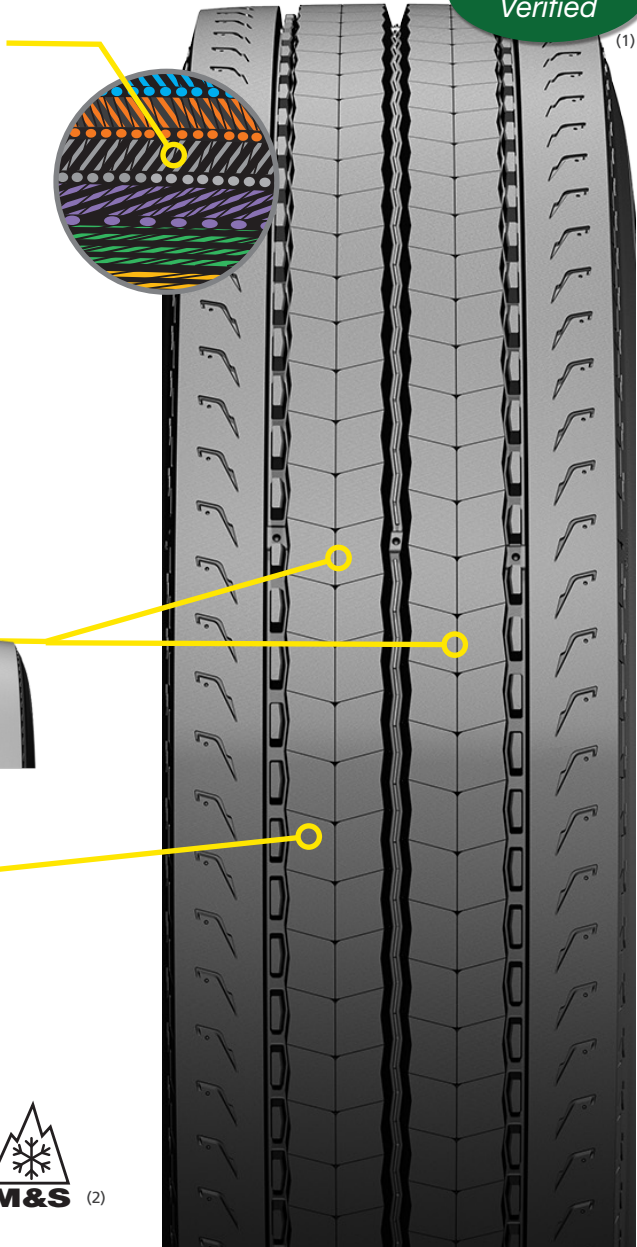

The wide arrow shows the start-of-life mounting direction for optimal tread performance. The small arrow demonstrates the alternate rolling direction which may be used for the second half of tread life. Michelin recommends that all tires on the same axle have the arrows facing in the same direction.



Size	Load Range	Catalog Number	Tread Depth		Max. Speed (*)		Loaded Radius		Overall Diameter		Approved Wheels (Measuring wheel listed first.)	Min. Dual Spacing (‡)		Revs Per Mile	Max. Load and Pressure Single				Max. Load and Pressure Dual			
			32nds	mm	mph	kph	in.	mm	in.	mm		in.	mm		lbs.	psi	kg.	kPa	lbs.	psi	kg.	kPa
315/80R22.5 (3)	L	02872	19	19	75	120	19.7	500	42.5	1080	9.00 (4)	13.8	351	487	9090	130	4125	900	8270	130	3750	900

(1) Based on internal tests against SmartWay® requirements. For more information on SmartWay® verified technologies, go to US: [www.epa.gov/smartway](http://www.epa.gov/smartway) or CA: <https://www.nrcan.gc.ca>.

(2) Meets the USTMA (U.S. Tire Manufacturers Association) snow traction performance requirements. Meets the Tire and Rubber Association of Canada (TRAC) requirements for severe snow traction.

(3) "No bus shall be operated with regrooved, recapped or retreaded tires on the front wheels." US Code of Federal Regulations: Title 49, Transportation; Part 393.75.

(4) Not approved for use with 8.25 wheel.

(\*) Exceeding the lawful speed limit is neither recommended nor endorsed.

(‡) Overall width will change 0.1 inch (2.5 mm) for each 1/4 inch change in wheel width. Minimum dual spacing should be adjusted accordingly.

MICHELIN® tires and tubes are subject to a continuous development program. Michelin North America, Inc. reserves the right to change product specifications at any time without notice or obligations.

MNA, Inc. continually updates its product information to reflect any changes in Industry Standards. Printed material may not reflect the current Load and Inflation information. Please visit [business.michelinman.com](http://business.michelinman.com) for the latest product information. The actual load and inflation pressure used must not exceed the wheel manufacturer's maximum conditions. Never exceed a wheel manufacturer's limits without permission from the component manufacturer.

TO FIND OUT MORE  
US: [business.michelinman.com](http://business.michelinman.com)  
CA: [michelintruck.com/en\\_CA](http://michelintruck.com/en_CA)

FIND US ON FACEBOOK  
[michelintruck](https://www.facebook.com/michelintruck)

CONTACT US BY EMAIL  
US: [business.michelinman.com/contact-us](mailto:business.michelinman.com/contact-us)  
CA: [michelintruck.com/en\\_CA/contact-us](mailto:michelintruck.com/en_CA/contact-us)

CONTACT US BY TELEPHONE  
US: 1-888-622-2306  
CA: 1-888-622-2306